

Development Of A Cloud-Based Condition Monitoring Scheme For Distribution Transformer Protection

Ayodele Isqeel Abdullateef^{1*}, Abdulkabir Olatunji Issa¹, Abdullah Sulaiman¹,
Momoh-Jimoh Eyiomika Salami², Abdulrahaman Otuoze¹

¹*Department of Electrical and Electronics, Faculty of Engineering and Technology,
University of Ilorin, Kwara, Nigeria.*

²*Department of Mechatronics, College of Engineering, Afe Babalola University,
Ado Ekiti, Nigeria.*

*abd_lateef.aii@unilorin.edu.ng

ABSTRACT

Distribution transformers are a necessity to ensure a reliable power supply to consumers and their inability to function properly or even breakdown should be avoided due to the high cost of replacing them. Distribution transformers are large in numbers and randomly distributed in cities and there is a need to accurately monitor their daily/hourly performance. To achieve this, real-time monitoring of the transformer's health status is proposed rather than the use of the traditional approach involving physical inspection and testing which is slow, tedious and time-consuming. This paper presents a cloud-based monitoring scheme applied to a prototype distribution transformer. A 10kVA, 0.415 kV prototype distribution transformer has been acquired and connected to three residences for data acquisition. A data acquisition system has been developed to monitor and record the parameters of the prototype transformer for 14 days. The parameters, monitored in real-time include load current, phase voltage, transformer oil level, ambient temperature and oil temperature. The acquired real-time data of the transformer is validated with the standard measuring instrument. An algorithm was developed to transmit and log the data to ThinkSpeak cloud server via node MCU (ESP 8266). Results obtained in this study, which can be visualized via the graphical user interface of ThinkSpeak, indicate that the proposed scheme can acquire vital data from the distribution transformers and transmit the information to the monitoring centre.

Keywords: Distribution transformer, Power supply, Cloud-based monitoring, Data acquisition system, Consumer load.

1. INTRODUCTION

Distribution transformers are one of the most important parts of equipment in the power system structure. Besides performing the voltage transformation to the level required by the consumers, its rating dictates the load distribution in the power system network and as such, the ratings are not to be exceeded for the proper functioning of the transformers. Generally, distribution transformers have a long life span, around 30 -50 years, if they are operated under normal conditions [1, 2] and can withstand a certain degree of overloading for some time without serious consequences. However, the overloading of the transformer should be avoided so as not to accelerate its ageing

**Ayodele Isqeel Abdullateef, Abdulkabir Olatunji Issa, Abdullah Sulaiman,
Momoh-Jimoh Eyiomika Salami, Abdulrahaman Okino Otuoze
Development of A Cloud-Based Condition Monitoring Scheme for Distribution
Transformer Protection**

which is affected by heat generated from the overload [3, 4]. To achieve this, real-time monitoring of the transformer's health status is necessary.

Unfortunately, the health status of the transformers, which includes among others, the monitoring of the temperature oil and connected loads had often been carried out manually whenever there is a fault or breakdown. Manual monitoring involves physical inspection and testing, to diagnose suspected faults. Notably, the system has to be de-energized during manual inspection, creating total black-out conditions for the consumer within the period of maintenance. Regrettably, manual method is slow, tedious, time consuming and affects the economic growth of a country, which is a function of the availability of a constant power supply [5-7]. Identification of transformer's fault at incipient is necessary to prevent breakdown and interruption of power supplies to the end-users. The transformer's fault occurs due to an increase in load which is accompanied by an increase in winding temperature and insulation degradation [4, 8].

Various methods have been proposed to monitor transformer health conditions in the last decade. Some of these methods are based on global system Global System for Mobile Communications (GSM) technology [9-11]. For instance, Patil, et al. [12] proposed transformer health condition monitoring through GSM technology. The study focused on the development of a low-cost device to monitor the health condition of a distribution transformer. A GSM-based monitoring system proposed by Ojo, et al. [13] checks the temperature level of the distribution transformer continuously and predicts faults such as overheating and overcurrent. Furthermore, a transformer monitoring and control system for remote electric power grids has been proposed [14]. The study used GSM technology to monitor the load current, transformer oil level and phase voltage. The system sends an Short Message Service (SMS) whenever an abnormality on the transformer is detected according to some predefined instructions and policies that are stored on the embedded system EEPROM.

Furthermore, the Internet of Things (IoT) has been proposed by different authors to monitor the health conditions of distribution transformers remotely at regular intervals [15-18]. Kwarteng, et al. [19] proposed an IoT Based monitoring system for the distribution transformer. The health index of the transformer is determined based on a change in current values on phases, oil level moisture content and load ability. A smart transformer monitoring and controlling system using IoT has been proposed [20, 21]. The studies analyzed parameters such as voltage, current, temperature and oil level to achieve transformer monitoring.

Furthermore, artificial intelligence techniques have been proposed to diagnose and monitor the health status of distribution transformers [22-25]. A condition monitoring device for distribution transformers carried out by Jaiswal, et al. [26] used fuzzy logic approach to monitor and diagnose the health conditions of a transformer. The load current, transformer oil level and phase voltages were some of the parameters monitored. The fuzzy rules used in the study simplify the necessary calculations for the utilities, and consequently improve the health indices of distribution transformers as compared with the manual computation method used by the utility for data observation. One of the main difficulties with the different proposed methods is the accessibility of the parameter in real-time while the transformer is loaded. Thus, this paper focus on the development of a cloud-based condition monitoring device for a prototype distribution transformer on load. This device measures and record the

operating parameters of the transformer and send them to a monitoring centre in real-time, which provides useful information about the health condition of the transformer.

2. METHODOLOGY

The general layout of the proposed system is depicted in Figure 1. It consists mainly of the prototype transformer, the data acquisition system and the load. The prototype transformer, shown in Figure 2, is a three-phase 10kVA, 415V/220V, oil natural air natural (ONAN) transformer. It has similar characteristics to a conventional distribution transformer and thus was used for the data collection. However, the conventional transformer is bigger in size and ratings which determines the load capacities as compared to the prototype transformer employed in this study. The data acquisition system connected to the prototype is subdivided into the transducer, microcontroller and Wi-Fi module.

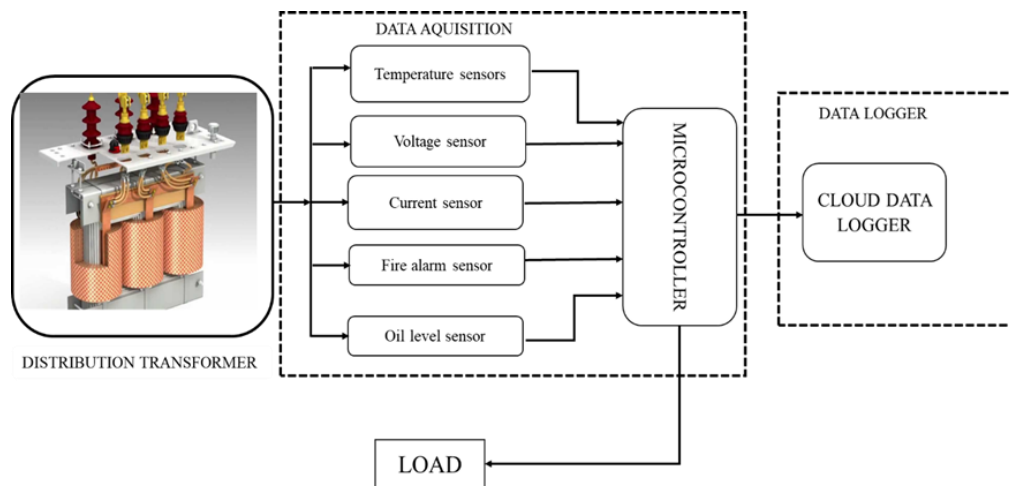

FIGURE 1. Cloud-based condition monitoring of distribution transformer

The transducers sense the required parameters and conditioned the signals which are connected to the microcontroller for the computation based on the instructions. The microcontroller carried out the instructions to log in the data in real-time to the cloud server via the data logger at preset time intervals. These data are displayed and stored for further analysis.



FIGURE 2. Three Phase distribution transformer

2.1 LOAD ASSESSMENT FOR PROTOTYPE TRANSFORMER RATING

The assessment of the number of appliances in each of the residences with their power ratings is given in Table 1. This was carried out to know the total power demand to prevent the overloading of the prototype distribution transformer.

TABLE 1.
Appliances rating of the residences

| Residence A | Appliances | Rate (watt) | Quantity | Total power (watt) |
|-------------|-----------------|-------------|--------------|--------------------|
| | Bulb | 7 | 5 | 35 |
| | Bulb | 10 | 4 | 40 |
| | Bulb | 18 | 3 | 54 |
| | Tv | 200 | 1 | 200 |
| | Fridge | 550 | 1 | 550 |
| | Fan | 80 | 2 | 160 |
| | Iron | 800 | 1 | 800 |
| | Blender | 250 | 1 | 250 |
| | Decoder | 15 | 1 | 15 |
| | | | Total | 2104 |
| Residence A | | | | |
| | Bulb | 18 | 6 | 108 |
| | Bulb | 11 | 4 | 44 |
| | Bulb | 100 | 3 | 300 |
| | Washing machine | 150 | 1 | 150 |
| | Fridge | 350 | 1 | 350 |
| | Tv | 110 | 1 | 110 |
| | Dispenser | 550 | 1 | 550 |
| | Decoder | 15 | 1 | 15 |
| | Fan | 150 | 1 | 150 |
| | Electric kettle | 1200 | 1 | 1200 |
| | | | Total | 2977 |
| Residence C | | | | |

| | | | |
|---------------------------|------|--------------|-------------|
| Bulb | 100 | 2 | 200 |
| Bulb | 10 | 6 | 60 |
| Bulb | 28 | 2 | 56 |
| Bulbs | 18 | 3 | 54 |
| Tv | 175 | 1 | 175 |
| Freezer | 750 | 1 | 750 |
| Fan | 80 | 2 | 160 |
| Laptop | 275 | 1 | 275 |
| Decoder | 15 | 1 | 15 |
| Iron | 1000 | 1 | 1000 |
| | | Total | 2745 |
| Total power Demand | | | 7826 |

The total power required by the residences is 7.826kW. Consequently, a 10kVA, three-phase prototype transformer has been used and its specifications are shown in Table 2.

TABLE 2.
Distribution transformer Specifications

| S/n | Basic Transformer Information | Ratings |
|-----|--|----------------------------------|
| 1 | Power | 10 kVA |
| 2 | No. of phases | 3 phase |
| 3 | Frequency | 50 Hz ($\pm 5\%$) |
| 4 | Type of cooling | ONAN (Oil natural / Air natural) |
| 5 | No. of windings | Two winding Transformers |
| 6 | Method of connection | Delta/ Star |
| 7 | Rated top oil rise over ambient temperature | 40°C |
| 8 | Rated hot spot rise over top oil temperature | 45°C |
| 9 | Winding exponent "m" | 0.9 |
| 10 | Output voltage | (415V $\pm 10\%$) |
| 11 | Current (primary/secondary) | 45A / 14.11A |

3. DATA ACQUISITION SYSTEM PROCEDURE

The selection of appropriate sensors and their calibrations are essential in the development of a data acquisition system. The sensors' calibration validates the accuracy and reproducibility of the measuring equipment which are fundamental requirements for the proposed device.

3.1 SELECTION AND CALIBRATION OF THE SENSORS

3.1.1 VOLTAGE SENSOR

A voltage sensor was used to measure the AC supply voltage in the system and transferred to the microcontroller for further processing. The experimental setup for the voltage sensor is shown in Figure 3. The sensor is calibrated such that the output on the serial monitor gives a close range of value when compared with a digital multimeter.

**Ayodele Isqeel Abdullateef, Abdulkabir Olatunji Issa, Abdullah Sulaiman,
Momoh-Jimoh Eyiomika Salami, Abdulrahaman Okino Otuoze**
**Development of A Cloud-Based Condition Monitoring Scheme for Distribution
Transformer Protection**

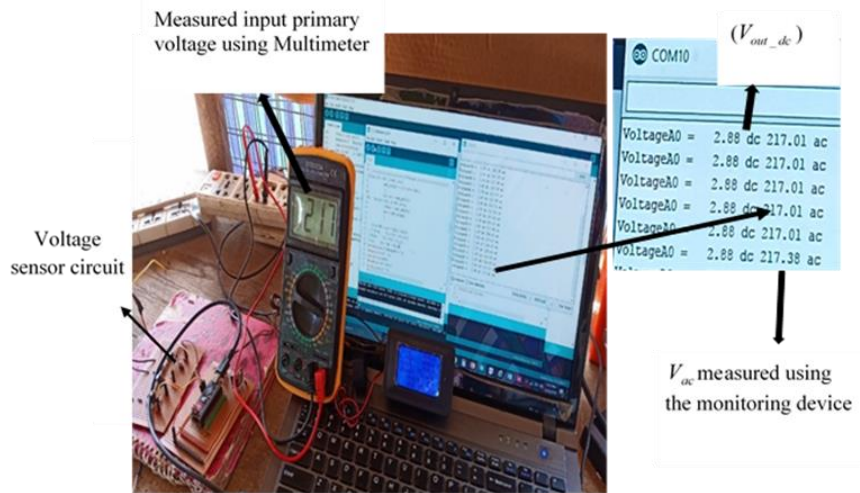

FIGURE 3. Experimental setup for voltage calibration

3.1.2 CURRENT SENSOR

A current sensor is a device that detects electric current in a wire and generates a signal proportional to that current. ACS 712 hall effect current sensor was chosen in this study due to its level of accuracy as compared with the other current sensors. The experimental setup for current sensor calibration is shown in Figure 4, a standard digital multimeter, connected in series with the load was used to measure the load current, and the readings were compared with the values recorded by the current sensor module. The result shows that the calibrated value and the measured value are practically equal.

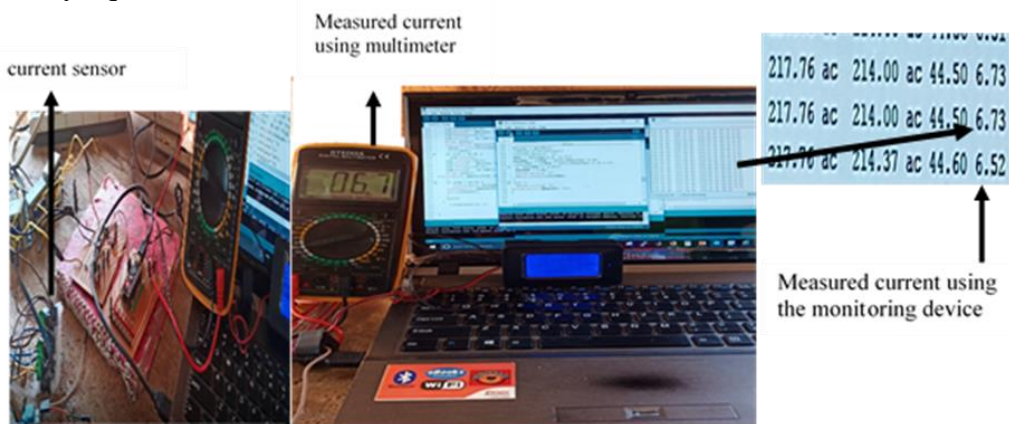

FIGURE 4. Experimental setup for current calibration

3.1.3 TEMPERATURE SENSOR

Temperature sensors are used to measure the temperature or heat of a measurand. They could be contact or non-contact type; the contact types need to be physically attached to the measurand, and the non-contact type uses convection and radiation to detect the temperature of objects that generally emits radiation as heat. Depending on the application, a thermocouple, thermistor or thermostat can serve as a temperature

sensor. In this study, RTD PT100 and DHT 111 temperature sensors were used for oil and ambient temperature monitoring respectively. The experimental set-up for temperature measurement is illustrated in Figure 5, the values read by the monitoring device were compared with that of the digital thermometer for validation. The result shows that the calibrated value and the measured value are approximately equal.

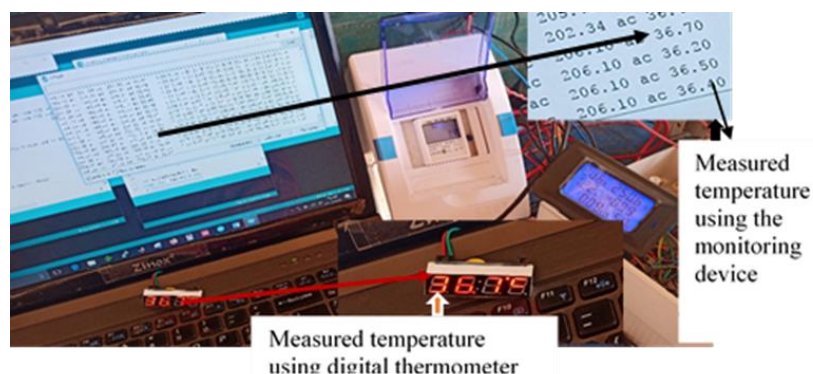

FIGURE 5. Experimental setup for temperature calibration

3.1.4 LIQUID LEVEL SENSOR

A liquid level sensor detects the level of any liquid or fluid in an open or closed system. The oil in a transformer is for cooling and insulation purposes and requires to be kept at an appropriate level for transformer functionality. To achieve this, a float type level sensor shown in Figure 6 was used to detect/monitor the oil level is employed. Its specification is illustrated in Table 3.



FIGURE 6. LS 10 level sensor

3.1.5 MICROCONTROLLER SELECTION

A microcontroller is a compact integrated circuit designed to govern a specific operation in an embedded system. A typical microcontroller consists of a processor, memory and input/output (I/O) peripherals on a single chip. ATmega 328p microcontroller shown in Figure 7 was chosen, due to its flexibilities and availabilities, other notable advantages are the required memory, low power consumption and low cost. The Atmel 8-bit AVR RISC-based microcontroller combines 32 KB ISP flash memory with read-while-write capabilities. It has 1 KB EEPROM, 2 KB SRAM, 23 general purpose I/O lines and 32 general purpose working registers. The device operates between 1.8-5.5 volts.

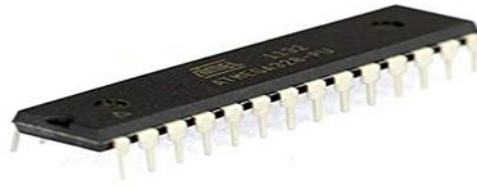

FIGURE 7. ATmega328P microcontroller

3.1.6 CLOUD DATA LOGGER

Data loggers are electronic devices which record parameters over time. The data logger receives the information and stores it on the chip for further usage. NodeMCU data logger manufactured by Shenzhen zhiyi technology co., Ltd., was chosen because it is an open source Lua based firmware for the ESP8266 wireless system-on-a-chip (SOC) from Espressif. The device uses an on-module flash-based SPIFFS file system, which is responsible for cloud data logging after a successful data acquisition. Figure 8 shows a NodeMCU ESP8266 module.



FIGURE 8. NodeMCU ESP8266 module

4. DEVELOPMENT OF AN ALGORITHM FOR THE MONITORING DEVICE

An algorithm is a step-by-step method of solving a problem. It is commonly used for data processing, calculation and other related computer and mathematical operations. Figure 9 shows the flow chart of the cloud-based condition monitoring device. The monitoring device obtained the transformer parameters data, such as phase voltage, load current, personnel temperature value and oil level. These data were processed to check if the values of the measured data are above the threshold limit. The threshold limit can occur when there is prolonged overloading and/or a low level of transformer oil, which consequently leads to a sustained rise in the temperature. These values are stored, and checked if Wi-Fi connection is established for proper logging of data into the cloud in real-time. In addition, a fault signal in form of SMS is sent through a GSM module to the concerned technical.

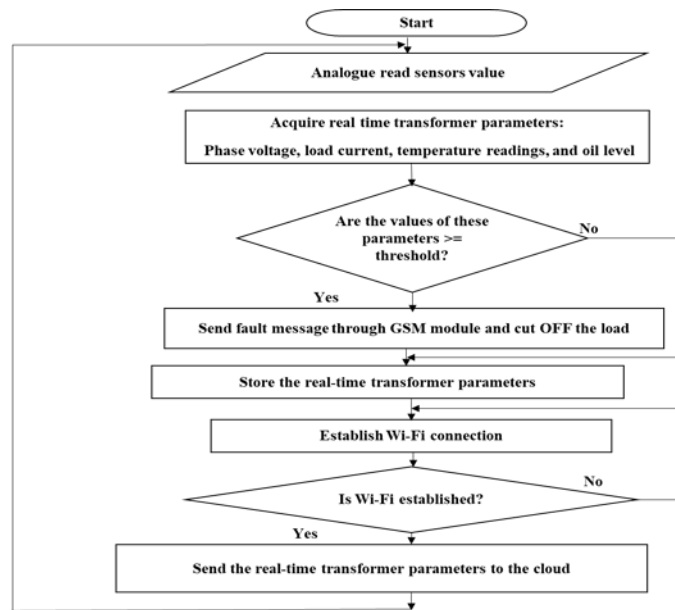

FIGURE 9. Algorithm flow chart for the monitoring device

4.1 THINGSPEAK I/O CLOUD SERVER

ThingSpeak is an open data platform for the Internet of Things which allows aggregation, visualisation, and analyses of real-time data streams in the cloud and gets data from other channels using an application programming interface (API). The data is further used to study the behaviour of the transformer. To perform operations in ThingSpeak tool, users must have an account and a channel.

5. CONSTRUCTION OF THE MONITORING DEVICE

The complete circuit diagram of the cloud-based monitoring device for the transformer carried out via Proteus 8 professional, is shown in Figure 10.

**Ayodele Isqeel Abdullateef, Abdulkabir Olatunji Issa, Abdullah Sulaiman,
Momoh-Jimoh Eyiomika Salami, Abdulrahaman Okino Otuoze**
**Development of A Cloud-Based Condition Monitoring Scheme for Distribution
Transformer Protection**

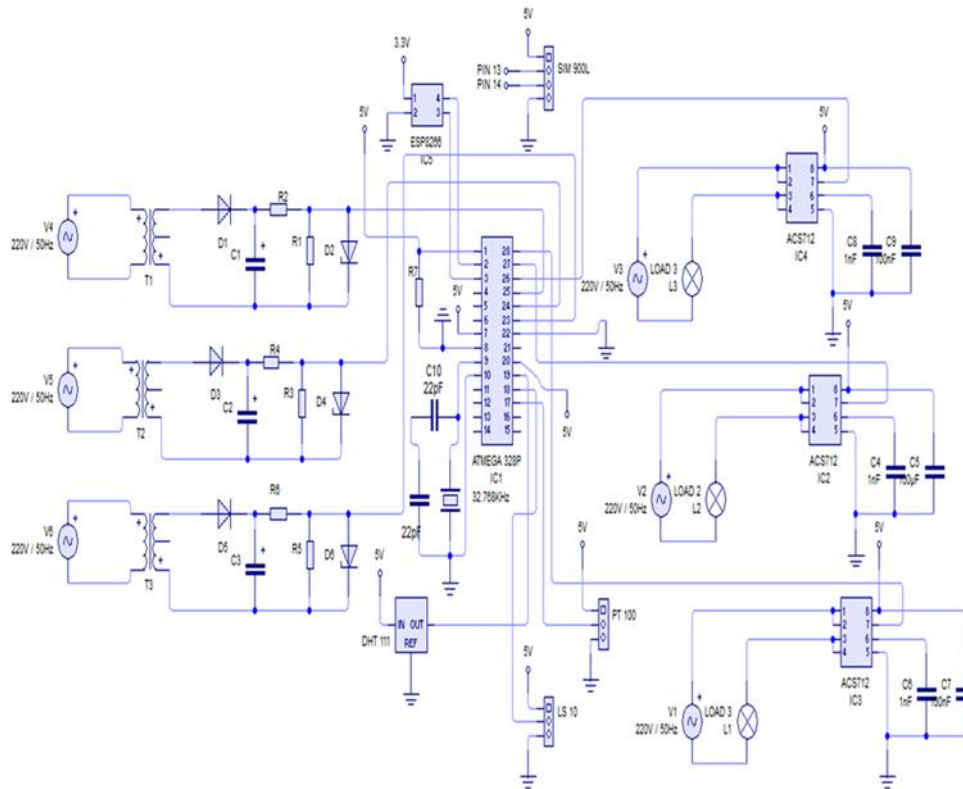

FIGURE 10. Circuit diagram of the monitoring device

The circuit consists of a microcontroller and an oscillator circuit. There are three voltage sensor circuits and current sensor modules connected to the microcontroller IC. The voltage sensor circuits are connected to analogue pin 23, 24, 25 of the microcontroller IC respectively. Similarly, the current sensors modules are connected to analogue pins 26, 27, and 28 respectively. The ambient temperature sensor and hotspot temperature sensor were connected respectively to the digital input pins 13 and 14. Esp8266 is connected to the UART pins 2 and 3 of the IC. These sensors were fitted to the transformer as indicated in Figure 12 for necessary data acquisition. The output from each sensor in form of voltages was fed to the Atmega 328p microcontroller for processing. The output of the microcontroller is transmitted to the cloud server in real-time via the cloud data logger (ESP8266) at preset intervals. These data are stored and displayed for further analysis.

To realise Figure 10, the components used were tested with the aid of a digital multimeter which ensures the identification of faulty components. Thereafter, the components were assembled on a breadboard, according to the circuit design, and tested before it was transferred to the Vero board for permanent soldering and construction.

The laboratory testing for the developed device is given in Figure 11, to ensure the functionality of each stage and the accuracy of the logged data. The three residences are represented by a variable load board consisting of different wattages of incandescence lamps, the primary source is connected to a three-phase input while the secondary source is connected to the load through the developed device. The oil level

sensor and oil temperature sensor were used to check the oil level and oil temperature of the transformer respectively.

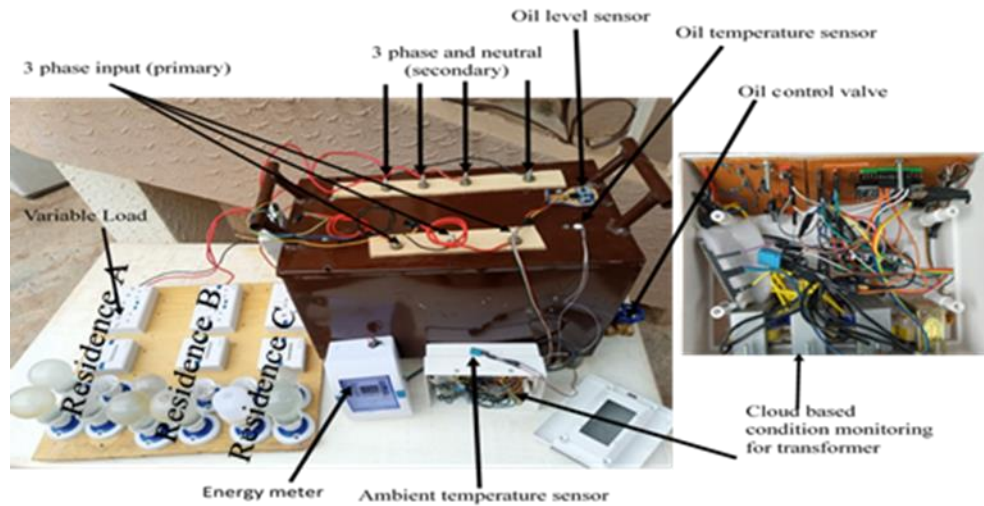

FIGURE 11. Experimental setup for cloud-based condition monitoring device

5.1 REAL-TIME TRANSFORMER MONITORING

To acquire the real-time data of the prototype distribution transformer, three houses were considered and connected to the transformer via the developed monitoring device as depicted in. Figure 12, where each of the residences is supplied with a single-phase line.

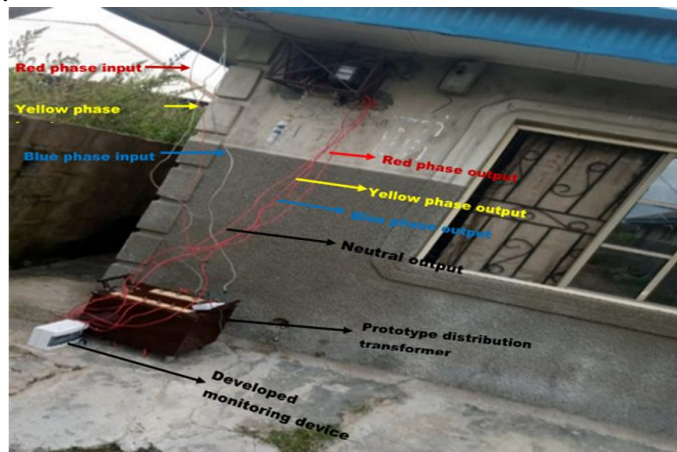

FIGURE 12. Wiring connection of the device to the residences

6. RESULTS AND DISCUSSION

Figures 13 to 16 indicate the graphical user interface of the acquired data stored in the cloud server for two weeks for a 24 hrs load cycle. The data consists of voltages, currents, active power, reactive power, apparent power, power factor, ambient temperature, oil temperature and oil level. These data are presented in Table 3 and

**Ayodele Isqeel Abdullateef, Abdulkabir Olatunji Issa, Abdullah Sulaiman,
Momoh-Jimoh Eyiomika Salami, Abdulrahaman Okino Otuoze**
**Development of A Cloud-Based Condition Monitoring Scheme for Distribution
Transformer Protection**

Table 4. The real-time voltage and current measurements in each of the phases on the cloud server are indicated in Figure 13 and Figure 14.

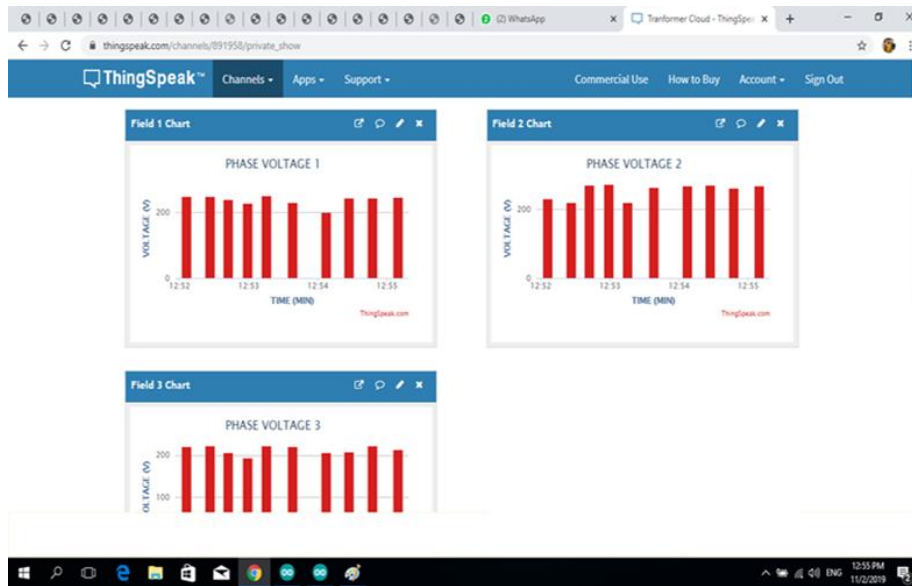

FIGURE 13. Real-time monitoring of three-phase voltage of distribution transformer on the thingSpeak server

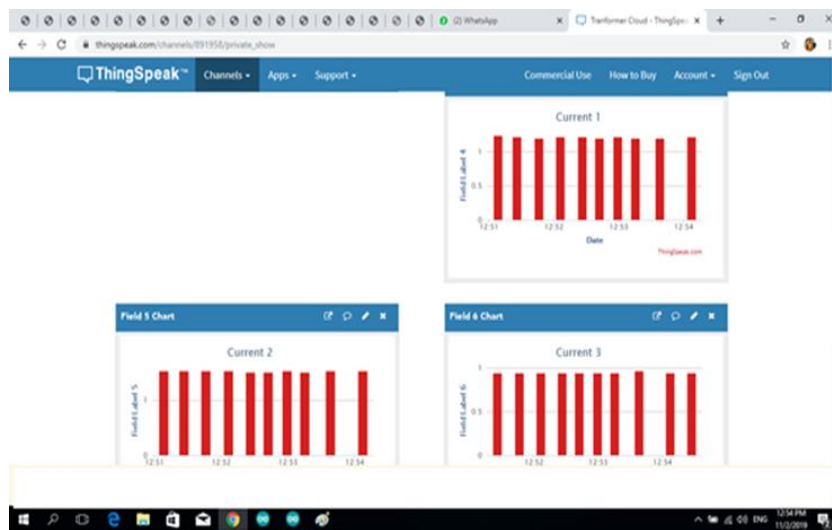

FIGURE 14. Real-time monitoring of the three-phase current of the distribution transformer on the thingSpeak server

Figure 15 shows the power factor for the three-phase on ThingSpeak, while Figure 16 shows the oil temperature, ambient temperature and oil level.

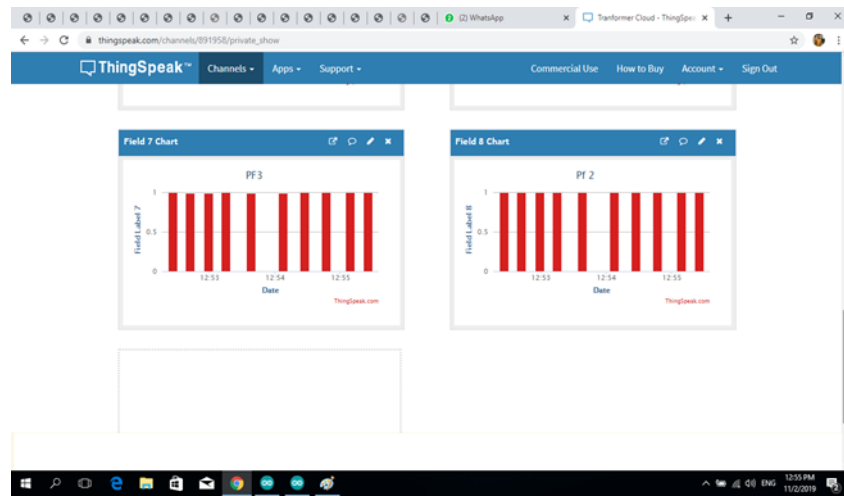

FIGURE 15. Real-time monitoring of power factors on distribution transformer on the ThingSpeak server

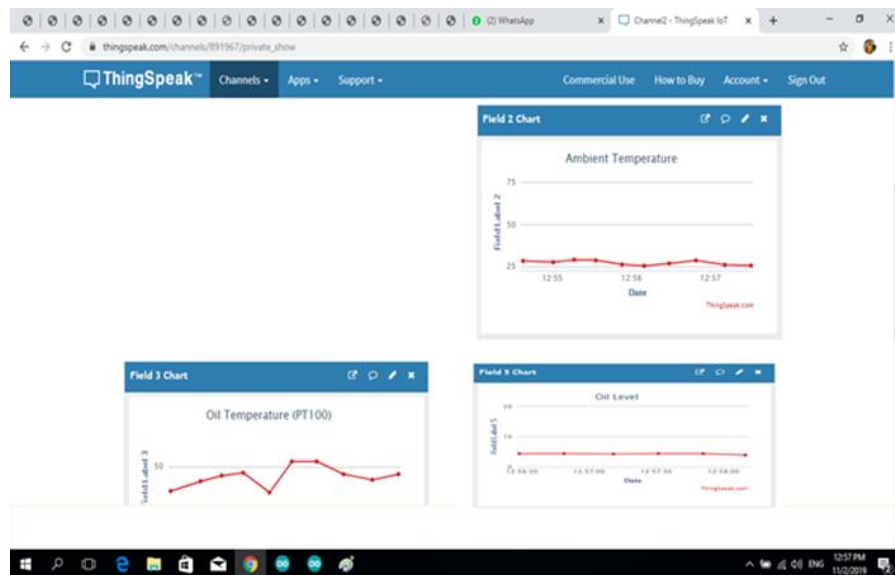

FIGURE 16. Real-time monitoring of transformer ambient temperature, oil temperature and oil level on the thingSpeak server

The average weekday transformer parameters for a 24 hours load cycle in each of the houses are shown in Figure 17. While Table 3 shows the average weekend transformer parameters for a 24 hours load cycle in each of the residences.

**Ayodele Isqeel Abdullateef, Abdulkabir Olatunji Issa, Abdullah Sulaiman,
Momoh-Jimoh Eyiomika Salami, Abdulrahaman Okino Otuoze**
Development of A Cloud-Based Condition Monitoring Scheme for Distribution Transformer Protection

TABLE 3.
Average weekdays transformer parameters for 24 hours load cycle in each of the residence

| Time H | Line voltage (V) | | | Current (A) | | | Active power (W) | | | Apparent power (kVA) | | | Power factor | | |
|-----------|------------------|-------|-------|-------------|------|------|------------------|---------|---------|----------------------|---------|---------|--------------|------|------|
| | V1 | V2 | V3 | I1 | I2 | I3 | P1 | P2 | P3 | S1 | S2 | S3 | PF 1 | PF 2 | PF 3 |
| 1:00 | 225.2 | 215.5 | 216.1 | 2.58 | 2.68 | 3.54 | 574.70 | 571.76 | 749.35 | 580.50 | 577.54 | 764.64 | 0.99 | 0.99 | 0.98 |
| 2:00 | 225.4 | 216.6 | 216.5 | 2.25 | 2.55 | 2.85 | 502.08 | 546.81 | 610.85 | 507.15 | 552.33 | 617.03 | 0.99 | 0.99 | 0.99 |
| 3:00 | 223.2 | 216.1 | 211.1 | 2.49 | 2.18 | 2.91 | 550.21 | 461.68 | 608.16 | 555.77 | 471.10 | 614.30 | 0.99 | 0.98 | 0.99 |
| 4:00 | 218.1 | 216.5 | 212.8 | 2.59 | 3.25 | 3.81 | 559.23 | 696.59 | 802.66 | 564.88 | 703.63 | 810.77 | 0.99 | 0.99 | 0.99 |
| 5:00 | 217.8 | 210.1 | 209.1 | 3.87 | 3.21 | 3.22 | 826.03 | 667.68 | 666.25 | 842.89 | 674.42 | 672.98 | 0.98 | 0.99 | 0.99 |
| 6:00 | 217.6 | 209.2 | 208.9 | 4.78 | 4.37 | 4.25 | 1029.73 | 905.06 | 878.95 | 1040.13 | 914.20 | 887.83 | 0.99 | 0.99 | 0.99 |
| 7:00 | 216.8 | 209.4 | 206.2 | 5.82 | 5.75 | 4.98 | 1249.16 | 1179.97 | 1016.61 | 1261.78 | 1204.05 | 1026.88 | 0.99 | 0.98 | 0.99 |
| 8:00 | 218.1 | 209.5 | 210.8 | 6.01 | 6.53 | 6.64 | 1284.57 | 1354.35 | 1385.71 | 1310.78 | 1368.04 | 1399.71 | 0.98 | 0.99 | 0.99 |
| 9:00 | 217.6 | 207.0 | 214.1 | 5.93 | 6.28 | 6.52 | 1277.46 | 1286.96 | 1381.33 | 1290.37 | 1299.96 | 1395.28 | 0.99 | 0.99 | 0.99 |
| 10:00 | 217.6 | 206.5 | 217.5 | 5.74 | 4.89 | 5.75 | 1236.53 | 999.69 | 1238.12 | 1249.02 | 1009.79 | 1250.63 | 0.99 | 0.99 | 0.99 |
| 11:00 | 217.7 | 213.2 | 214.4 | 3.24 | 4.76 | 4.65 | 698.29 | 1003.74 | 986.99 | 705.35 | 1013.88 | 996.96 | 0.99 | 0.99 | 0.99 |
| 12:00 | 217.8 | 213.5 | 215.2 | 3.33 | 4.52 | 4.52 | 710.77 | 945.72 | 962.08 | 725.27 | 965.02 | 971.80 | 0.98 | 0.98 | 0.99 |
| 13:00 | 217.6 | 212.4 | 212.0 | 3.54 | 3.78 | 4.15 | 762.60 | 793.35 | 871.00 | 770.30 | 801.36 | 879.80 | 0.99 | 0.99 | 0.99 |
| 14:00 | 217.7 | 215.1 | 217.5 | 3.43 | 3.47 | 3.42 | 739.24 | 738.59 | 728.97 | 746.71 | 746.05 | 743.85 | 0.99 | 0.99 | 0.98 |
| 15:00 | 217.7 | 213.5 | 213.2 | 3.78 | 3.95 | 4.22 | 806.45 | 834.89 | 890.71 | 822.91 | 843.33 | 899.70 | 0.98 | 0.99 | 0.99 |
| 16:00 | 217.6 | 212.4 | 210.1 | 4.89 | 5.18 | 5.81 | 1053.42 | 1089.23 | 1207.90 | 1064.06 | 1100.23 | 1220.10 | 0.99 | 0.99 | 0.99 |
| 17:00 | 217.6 | 203.5 | 211.0 | 5.86 | 6.75 | 7.78 | 1262.38 | 1359.89 | 1625.16 | 1275.14 | 1373.63 | 1641.58 | 0.99 | 0.99 | 0.99 |
| 18:00 | 218.2 | 207.2 | 210.2 | 7.69 | 7.94 | 7.83 | 1661.18 | 1628.72 | 1627.86 | 1677.96 | 1645.17 | 1644.30 | 0.99 | 0.99 | 0.99 |
| 19:00 | 218.2 | 210.5 | 209.8 | 7.78 | 8.82 | 8.79 | 1663.64 | 1838.04 | 1825.70 | 1697.60 | 1856.61 | 1844.14 | 0.98 | 0.99 | 0.99 |
| 20:00 | 218.3 | 210.2 | 208.3 | 7.85 | 8.85 | 8.98 | 1679.38 | 1841.67 | 1851.83 | 1713.66 | 1860.27 | 1870.53 | 0.98 | 0.99 | 0.99 |
| 21:00 | 223.5 | 206.4 | 211.5 | 6.51 | 5.86 | 7.85 | 1440.44 | 1197.41 | 1643.67 | 1454.99 | 1209.50 | 1660.28 | 0.99 | 0.99 | 0.99 |
| 22:00 | 225.0 | 209.5 | 211.2 | 4.79 | 4.98 | 5.98 | 1066.97 | 1032.88 | 1237.72 | 1077.75 | 1043.31 | 1262.98 | 0.99 | 0.99 | 0.98 |
| 23:00 | 223.4 | 214.5 | 214.2 | 4.3 | 3.69 | 5.58 | 951.01 | 783.59 | 1183.28 | 960.62 | 791.51 | 1195.24 | 0.99 | 0.99 | 0.99 |
| 24:00 | 224.2 | 215.1 | 214.6 | 2.21 | 3.32 | 4.86 | 490.53 | 706.99 | 1032.53 | 495.48 | 714.13 | 1042.96 | 0.99 | 0.99 | 0.99 |

TABLE 4.
Average weekends transformer parameters for 24 hours load cycle in each of the residence

| Time | Line voltage (V) | | | Current (A) | | | Active power (W) | | | Apparent power (KVA) | | | Power factor | | |
|-------|------------------|-------|-------|-------------|-------|------|------------------|---------|---------|----------------------|---------|---------|--------------|------|------|
| | H | V1 | V2 | V3 | I1 | I2 | I3 | P1 | P2 | P3 | S1 | S2 | S3 | 1 | PF 2 |
| 1:00 | 221.2 | 213.5 | 215.7 | 2.39 | 2.782 | 3.66 | 523.38 | 588.02 | 773.67 | 528.67 | 593.96 | 789.46 | 0.99 | 0.99 | 0.99 |
| 2:00 | 224.3 | 212.4 | 215.5 | 2.35 | 2.35 | 2.73 | 521.83 | 494.15 | 582.43 | 527.11 | 499.14 | 588.32 | 0.99 | 0.99 | 0.99 |
| 3:00 | 210.5 | 208.5 | 213.8 | 2.42 | 2.37 | 2.54 | 504.32 | 484.26 | 537.62 | 509.41 | 494.15 | 543.05 | 0.99 | 0.98 | 0.99 |
| 4:00 | 212.8 | 207.2 | 214.8 | 2.89 | 3.68 | 3.74 | 608.84 | 754.87 | 795.32 | 614.99 | 762.50 | 803.35 | 0.99 | 0.99 | 0.99 |
| 5:00 | 207.2 | 210.5 | 213.4 | 3.08 | 3.35 | 3.42 | 625.41 | 698.12 | 722.53 | 638.18 | 705.18 | 729.83 | 0.99 | 0.99 | 0.99 |
| 6:00 | 213.6 | 210.2 | 213.9 | 3.58 | 3.32 | 3.33 | 757.04 | 690.89 | 705.16 | 764.69 | 697.86 | 712.29 | 0.99 | 0.99 | 0.99 |
| 7:00 | 211.5 | 209.4 | 210.2 | 4.2 | 4.15 | 4.23 | 879.42 | 851.63 | 880.25 | 888.30 | 869.01 | 889.15 | 0.98 | 0.98 | 0.99 |
| 8:00 | 220.1 | 215.5 | 215.6 | 6.45 | 6.53 | 6.85 | 1391.25 | 1393.14 | 1462.09 | 1419.65 | 1407.22 | 1476.86 | 0.99 | 0.99 | 0.99 |
| 9:00 | 222.5 | 219.4 | 217.2 | 7.53 | 7.82 | 7.93 | 1658.67 | 1698.55 | 1705.17 | 1675.43 | 1715.71 | 1722.40 | 0.99 | 0.99 | 0.99 |
| 10:00 | 225.6 | 222.5 | 219.5 | 7.72 | 7.84 | 7.72 | 1724.22 | 1726.96 | 1677.59 | 1741.63 | 1744.40 | 1694.54 | 0.99 | 0.99 | 0.99 |
| 11:00 | 217.7 | 213 | 212.4 | 8.14 | 8.25 | 8.11 | 1754.36 | 1739.68 | 1705.34 | 1772.08 | 1757.25 | 1722.56 | 0.99 | 0.99 | 0.99 |
| 12:00 | 217.8 | 213.5 | 213 | 8.12 | 8.54 | 8.65 | 1733.17 | 1786.82 | 1824.03 | 1768.54 | 1823.29 | 1842.45 | 0.98 | 0.98 | 0.99 |
| 13:00 | 219.4 | 215.7 | 212.8 | 8.66 | 8.65 | 8.79 | 1881.00 | 1847.15 | 1851.81 | 1900.00 | 1865.81 | 1870.51 | 0.99 | 0.99 | 0.98 |
| 14:00 | 220.1 | 216.8 | 217.5 | 7.68 | 7.87 | 7.72 | 1673.46 | 1689.15 | 1645.52 | 1690.37 | 1706.22 | 1679.10 | 0.99 | 0.99 | 0.98 |
| 15:00 | 218.2 | 218.4 | 216.2 | 7.57 | 7.75 | 7.37 | 1618.74 | 1675.67 | 1577.46 | 1651.77 | 1692.60 | 1593.39 | 0.99 | 0.99 | 0.99 |
| 16:00 | 219.6 | 219.1 | 211 | 7.49 | 7.52 | 8.77 | 1628.36 | 1631.16 | 1831.97 | 1644.80 | 1647.63 | 1850.47 | 0.99 | 0.99 | 0.99 |
| 17:00 | 219.7 | 218.2 | 211.8 | 7.63 | 7.87 | 7.85 | 1659.55 | 1700.06 | 1646.00 | 1676.31 | 1717.23 | 1662.63 | 0.99 | 0.98 | 0.99 |
| 18:00 | 216.5 | 218.6 | 210.7 | 7.52 | 7.45 | 7.41 | 1611.80 | 1612.28 | 1545.67 | 1628.08 | 1628.57 | 1561.29 | 0.99 | 0.99 | 0.99 |
| 19:00 | 217.5 | 217.7 | 210.8 | 6.74 | 5.47 | 5.57 | 1436.63 | 1178.91 | 1162.41 | 1465.95 | 1190.82 | 1174.16 | 0.99 | 0.99 | 0.98 |
| 20:00 | 222.3 | 216.5 | 212.8 | 6.55 | 5.35 | 5.45 | 1426.94 | 1146.69 | 1148.16 | 1456.07 | 1158.28 | 1159.76 | 0.99 | 0.99 | 0.99 |
| 21:00 | 218.4 | 215.5 | 210.5 | 5.11 | 5.07 | 5.19 | 1104.86 | 1081.66 | 1081.57 | 1116.02 | 1092.59 | 1092.50 | 0.99 | 0.99 | 0.99 |
| 22:00 | 217.1 | 210.5 | 210.4 | 4.37 | 4.65 | 5.69 | 939.24 | 969.04 | 1173.23 | 948.73 | 978.83 | 1197.18 | 0.99 | 0.99 | 0.99 |
| 23:00 | 219.7 | 217.5 | 213.4 | 4.19 | 3.96 | 5.46 | 911.34 | 852.69 | 1153.51 | 920.54 | 861.30 | 1165.16 | 0.99 | 0.99 | 0.99 |
| 24:00 | 218.2 | 218.1 | 215.5 | 2.32 | 2.44 | 4.45 | 501.16 | 526.84 | 949.39 | 506.22 | 532.16 | 958.98 | 0.99 | 0.99 | 0.99 |

**Ayodele Isqeel Abdullateef, Abdulkabir Olatunji Issa, Abdullah Sulaiman,
Momoh-Jimoh Eyiomika Salami, Abdulrahaman Okino Otuoze**
**Development of A Cloud-Based Condition Monitoring Scheme for Distribution
Transformer Protection**

Figure 17 shows the daily power consumption of the residences. It is observed that the average power consumed in each of the residences at the early hours of the day steeply increased to around 1.160 kW at 10:00 hours and later decreased to approximately 0.74 kW at 14:00 hours. In addition, at 16:00 hours the average power consumed in each of the residences ascend to nearly 1.120 kW and sharply increased to a peak at 20:00 hours in the evening and later decreased for the rest of the hours.

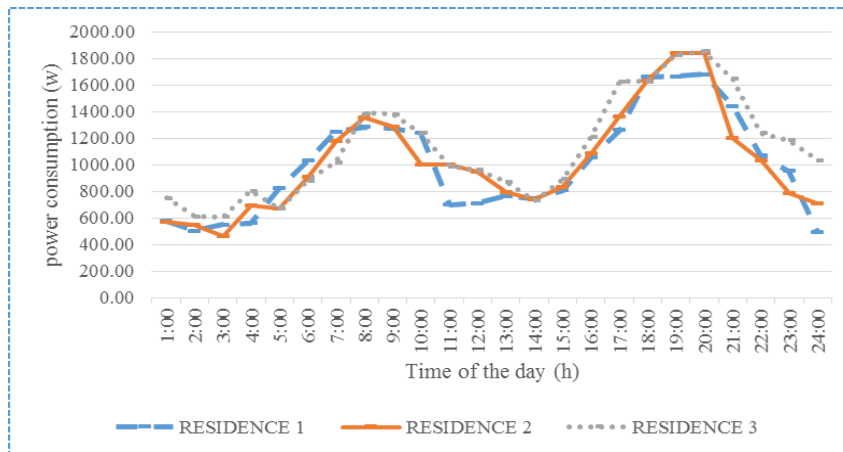

FIGURE 17. Average weekdays power consumed by the consumer in the residents for 24 hours load cycle

The average weekdays and weekends power consumed in 24 hours load cycle is given in Figure 18. The power consumed for both cases between 1:00 hours to 5:00 hours is nearly the same while a significant change occurs at 6:00 hours. However, the power consumed over the weekends rose steadily from approximately 4 kW at 8:00 hours to around 5.5 kW at 13 hours in the afternoon, and drop steadily to 2 kW at 24:00 hours. On the other hand, the weekday's power consumption steeply increases from 1.8 kW at 2:00 hours to 4 kW at 8:00 hours and falls to nearly 2 kW at 14:00 hours in the afternoon. In addition, the weekday's power consumed reached its peak at 5.3 kW at 20:00 hours. Therefore, the power consumed at the weekends rose during the afternoon compared to the power consumed during the weekdays which always increases in the evening time.

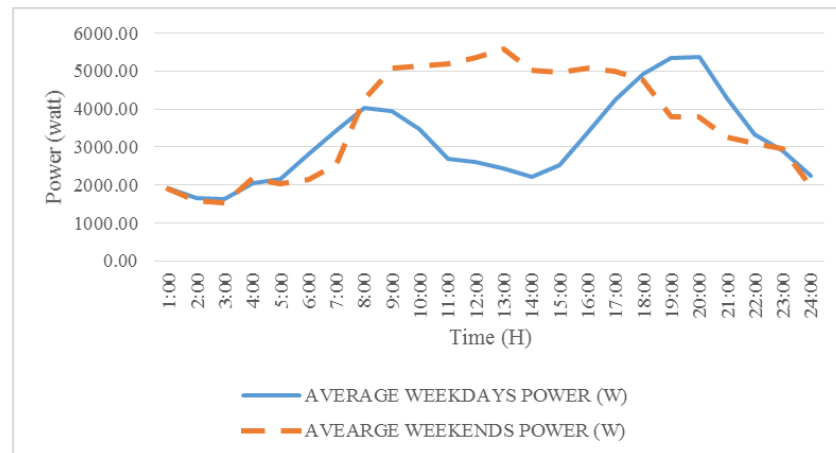

FIGURE 18. Average weekdays and weekends power consumed by the 3 residents for 24 hours load cycle

7. CONCLUSION

The development of a cloud-based condition monitoring scheme involving a data acquisition system has been carried out in this study. This device acquires the transformer parameters data, monitors it and sends the data to the cloud in real-time. The acquired data would be used to evaluate the power consumption by the residences and stored in the ThingSpeak cloud server. The transformer's loads vary for different days of operation. The loading of the transformer during the weekends is higher as compared to weekdays loading.

REFERENCES

- [1] J. Foros and M. Istad, "Health index, risk and remaining lifetime estimation of power transformers," *IEEE Transactions on Power Delivery*, vol. 35, no. 6, pp. 2612-2620, 2020.
- [2] P. Jarman, Z. Wang, Q. Zhong, and T. Ishak, "End-of-life modelling for power transformers in aged power system networks," in *CIGRE 2009 6th Southern Africa Regional Conference, Cape Town, Southern Africa*, 2009.
- [3] T. K. Saha and P. Purkait, *Transformer ageing: monitoring and estimation techniques*. John Wiley & Sons, 2017.
- [4] R. Godina, E. M. Rodrigues, J. C. Matias, and J. P. Catalão, "Effect of loads and other key factors on oil-transformer ageing: Sustainability benefits and challenges," *Energies*, vol. 8, no. 10, pp. 12147-12186, 2015.
- [5] R. A. Maqin and I. Sidharta, "The relationship of economic growth with human development and electricity consumption in Indonesia," *International Journal of Energy Economics Policy*, vol. 7, no. 3, pp. 201-207, 2017.
- [6] S.-H. Yoo and Y. Kim, "Electricity generation and economic growth in Indonesia," *Energy for Sustainable Development*, vol. 31, no. 14, pp. 2890-2899, 2006.
- [7] E. E. Okafor, "Development crisis of power supply and implications for industrial sector in Nigeria," *Studies of Tribes Tribals*, vol. 6, no. 2, pp. 83-92, 2008.
- [8] N. Lelekakis, D. Martin, and J. Wijaya, "Ageing rate of paper insulation used in power transformers Part 1: Oil/paper system with low oxygen concentration," *IEEE Transactions on Dielectrics Electrical Insulation*, vol. 19, no. 6, pp. 1999-2008, 2012.
- [9] A. Sharma and R. Behura, "GSM based Distribution Transformer Monitoring System," 2013.

**Ayodele Isqeel Abdullateef, Abdulkabir Olatunji Issa, Abdullah Sulaiman,
Momoh-Jimoh Eyiomika Salami, Abdulrahaman Okino Otuoze
Development of A Cloud-Based Condition Monitoring Scheme for Distribution
Transformer Protection**

- [10] W. Kepa, A. K. Luhach, M. Kavi, J. Fisher, and R. Luhach, "GSM based remote distribution transformer condition monitoring system," in *International Conference on Advanced Informatics for Computing Research*, 2020, pp. 59-68: Springer.
- [11] A.-R. Al-Ali, A. Khaliq, and M. Arshad, "GSM-based distribution transformer monitoring system," in *Proceedings of the 12th IEEE mediterranean electrotechnical conference (IEEE Cat. No. 04CH37521)*, 2004, vol. 3, pp. 999-1002: IEEE.
- [12] U. Patil, K. Mohan, H. Saurabh, and W. J. V.-I.-. Nilesh, "Transformer Health Condition Monitoring Using GSM Technology," 2016.
- [13] T. P. Ojo, A. O. Akinwumi, F. O. Ehiagwina, J. M. Ambali, and I. S. Olatinwo, "Design and Implementation of a GSM-based Monitoring System for a Distribution Transformer," *European Journal of Engineering Technology Research*, vol. 7, no. 2, pp. 22-28, 2022.
- [14] M. Jalilian *et al.*, "Design and implementation of the monitoring and control systems for distribution transformer by using GSM network," vol. 74, pp. 36-41, 2016.
- [15] S. Khule, "Condition Monitoring of Distribution Transformer Using Internet of Things (IoT)," *Journal of Advanced Research in Signal Processing Applications*, vol. 1, no. 2, pp. 9-13, 2021.
- [16] R. R. Pawar, P. A. Wagh, and S. Deosarkar, "Distribution transformer monitoring system using Internet of Things (IoT)," in *2017 International Conference on Computational Intelligence in Data Science (ICCIDS)*, 2017, pp. 1-4: IEEE.
- [17] V. Ravindran, R. Ponraj, C. Krishnakumar, S. Ragunathan, V. Ramkumar, and K. Swaminathan, "IoT-based smart transformer monitoring system with Raspberry Pi," in *2021 Innovations in Power and Advanced Computing Technologies (i-PACT)*, 2021, pp. 1-7: IEEE.
- [18] H. Jamal, M. F. N. Khan, A. Anjum, and M. K. Janjua, "Thermal monitoring and protection for distribution transformer under residential loading using internet of things," in *2018 IEEE global conference on internet of things (GCIoT)*, 2018, pp. 1-6: IEEE.
- [19] A. Kwarteng, S. K. Okrah, B. Asante, and P. Amanor, "Design and Construction of an IoT Based Distribution Transformer Condition Monitoring System," *The International Journal of Engineering Science*, vol. 10, no. 5, pp. 20-44, 2021.
- [20] S. Bhavarkar *et al.*, "IOT Based Distribution Transformer Monitoring and Controlling System," vol. 2, no. 1, 2019.
- [21] A. S. Amol, S. T. Mayur, V. S. Sumit, A. A. Ankit, S. J. Piyush, and N. G. Vivek, "Condition Monitoring of Distribution Transformer using IOT," *International Journal of Engineering Research & Technology*, vol. 9, no. 6, pp. 335-338, 2020.
- [22] M. Žarković and Z. Stojković, "Analysis of artificial intelligence expert systems for power transformer condition monitoring and diagnostics," *Electric Power Systems Research*, vol. 149, pp. 125-136, 2017.
- [23] Z. Wang, *Artificial intelligence applications in the diagnosis of power transformer incipient faults*. Virginia Polytechnic Institute and State University, 2000.
- [24] K. Hong, J. Pan, and M. Jin, "Transformer condition monitoring based on load-varied vibration response and GRU neural networks," *IEEE Access*, vol. 8, pp. 178685-178694, 2020.
- [25] C. Booth and J. R. J. N. McDonald, "The use of artificial neural networks for condition monitoring of electrical power transformers," vol. 23, no. 1-3, pp. 97-109, 1998.
- [26] G. C. Jaiswal, M. S. Ballal, and D. Tutakne, "Health index based condition monitoring of distribution transformer," in *2016 IEEE International Conference on Power Electronics, Drives and Energy Systems (PEDES)*, 2016, pp. 1-5: IEEE.